

Introduction to Capillary Electrophoresis

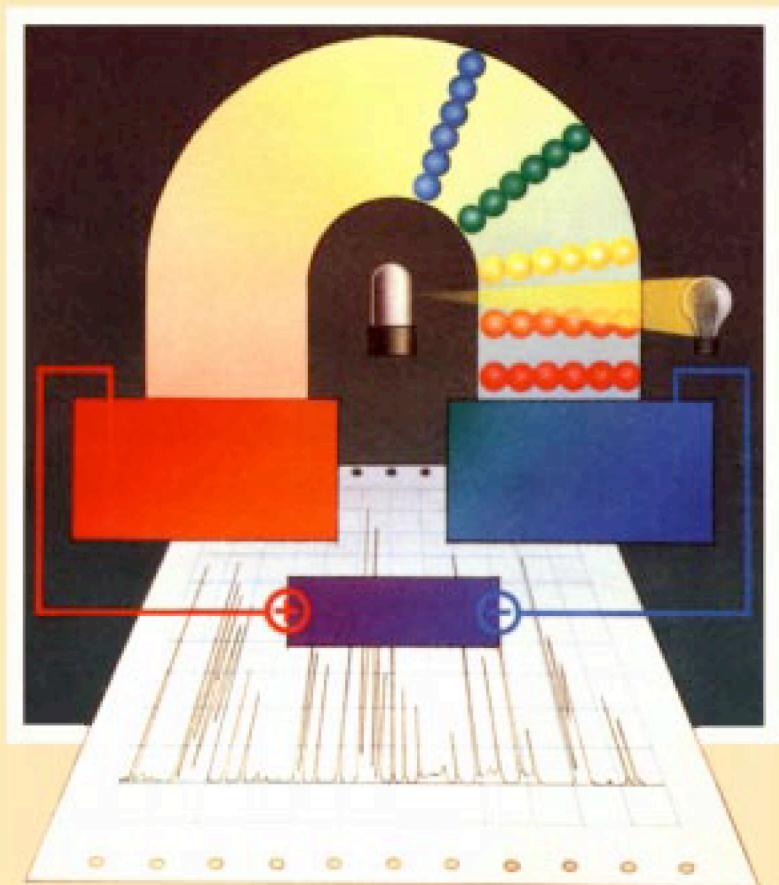

Contents

About this handbook	ii
Acronyms and symbols used	iii
Capillary electrophoresis	1
Electrophoresis terminology	3
Electroosmosis	4
Flow dynamics, efficiency, and resolution	6
Capillary diameter and Joule heating	9
Effects of voltage and temperature	11
Modes of capillary electrophoresis	12
Capillary zone electrophoresis	12
Isoelectric focusing	18
Capillary gel electrophoresis	21
Isotachopheresis	26
Micellar electrokinetic capillary chromatography	28
Selecting the mode of electrophoresis	36
Approaches to methods development by CZE and MECC	37
Suggested reading	40

About this handbook

This handbook, the first of a series on modern high performance capillary electrophoresis (CE), is intended for scientists who are contemplating use of or have recently started using this rapidly evolving family of techniques.

The goals of this book are: to introduce you to CE; to help you understand the mechanisms of the various modes of CE; to guide you in method selection; and to provide a set of approaches towards methods development for both large and small molecules.

Acronyms and symbols used

The following acronyms and symbols are used throughout this handbook.

BSA	bovine serum albumin
CE	capillary electrophoresis
CTAB	cetyltrimethylammonium bromide
CGE	capillary gel electrophoresis
CMC	critical micelle concentration
CZE	capillary zone electrophoresis
DMF	dimethylformamide
DMSO	dimethyl sulfoxide
E	electric field strength
EDTA	ethylenediaminetetraacetic acid
EOF	electroosmotic flow
EPF	electrophoretic flow
HPLC	high performance liquid chromatography
IEF	isoelectric focusing
ITP	isotachopheresis
LC	liquid chromatography
L_d	length of capillary to the detector
L_t	total capillary length
MECC	micellar electrokinetic capillary chromatography
μ_{ep}	electrophoretic mobility
PAGE	polyacrylamide gel electrophoresis
PCR	polymerase chain reaction
pI	isoelectric point
SDS	sodium dodecyl sulfate
THF	tetrahydrofuran
UV	ultraviolet
V	volt
V	voltage
v_{eo}	electroosmotic flow velocity
v_{ep}	electrophoretic velocity

Capillary electrophoresis

Capillary electrophoresis (CE) is a family of related techniques that employ narrow-bore (20-200 μm i.d.) capillaries to perform high efficiency separations of both large and small molecules. These separations are facilitated by the use of high voltages, which may generate electroosmotic and electrophoretic flow of buffer solutions and ionic species, respectively, within the capillary. The properties of the separation and the ensuing electropherogram have characteristics resembling a cross between traditional polyacrylamide gel electrophoresis (PAGE) and modern high performance liquid chromatography (HPLC).

CE offers a novel format for liquid chromatography and electrophoresis that:

- employs capillary tubing within which the electrophoretic separation occurs;
- utilizes very high electric field strengths, often higher than 500 V/cm;
- uses modern detector technology such that the electropherogram often resembles a chromatogram;
- has efficiencies on the order of capillary gas chromatography or even greater;
- requires minute amounts of sample;
- is easily automated for precise quantitative analysis and ease of use;
- consumes limited quantities of reagents;
- is applicable to a wider selection of analytes compared to other analytical separation techniques.

The basic instrumental configuration for CE is relatively simple. All that is required is a fused-silica capillary with an optical viewing window, a controllable high voltage power supply, two electrode assemblies, two buffer reservoirs, and an ultraviolet (UV) detector. The ends of the capillary are placed in the buffer reservoirs and the optical viewing window is aligned with the detector. After filling the capillary with buffer, the sample can be introduced by dipping the end of the capillary into the sample solution and elevating the immersed capillary a foot or so above the detector-side buffer reservoir. Virtually all of the pre-1988 work in CE was

carried out on homemade devices following this basic configuration. While relatively easy to use for experimentation, these early systems were inconvenient for routine analysis and too imprecise for quantitative analysis.

A diagram of a modern instrument, the P/ACE™ 2000 Series, is illustrated in Figure 1. Compared to the early developmental instruments, this fully automated instrument offers computer control of all operations, pressure and electrokinetic injection, an autosampler and fraction collector, automated methods development, precise temperature control, and an advanced heat dissipation system. Automation is critical to CE since repeatable operation is required for precise quantitative analysis.

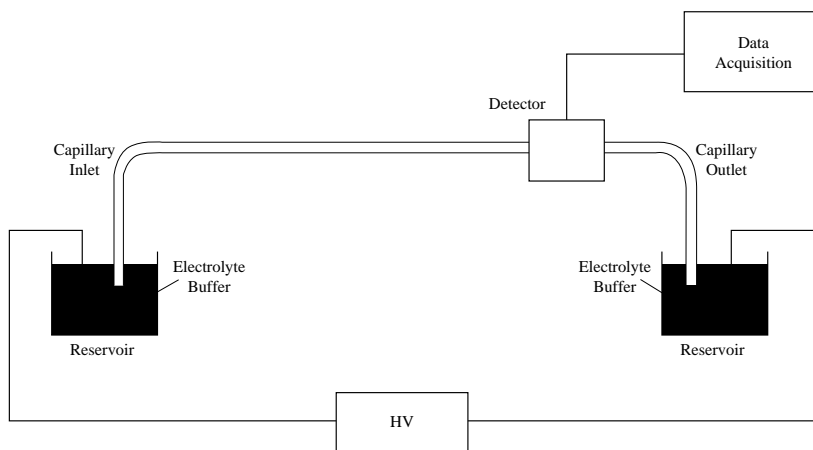

Figure 1. Basic Configuration of the P/ACE Capillary Electrophoresis System

Electrophoresis terminology

There are a few significant differences between the nomenclature of chromatography and capillary electrophoresis. For example, a fundamental term in chromatography is **retention time**. In electrophoresis, under ideal conditions, nothing is retained, so the analogous term becomes **migration time**. The **migration time** (t_m) is the time it takes a solute to move from the beginning of the capillary to the detector window.

Other fundamental terms are defined below. These include the **electrophoretic mobility**, μ_{ep} (cm^2/Vs), the **electrophoretic velocity**, v_{ep} (cm/s), and the **electric field strength**, E (V/cm). The relationships between these factors are shown in Equation 1.

$$\mu_{ep} = \frac{v_{ep}}{E} = \frac{L_d / t_m}{V / L_t} \quad (1)$$

Several important features can be seen from this equation:

- 1) Velocities are measured terms. They are calculated by dividing the migration time by the length of the capillary to the detector, L_d .
- 2) Mobilities are determined by dividing the velocity by the field strength. The mobility is independent of voltage and capillary length but is highly dependent on the buffer type and pH as well as temperature.
- 3) Two capillary lengths are important: the length to the detector, L_d , and the total length, L_t . While the measurable separation occurs in the capillary segment, L_d , the field strength is calculated by dividing the voltage by the length of the entire capillary, L_t . The excess capillary length, $L_t - L_d$, is required to make the connection to the buffer reservoir. For the P/ACE system, this length is 7 cm. By reversing the configuration of the system, this 7-cm length of capillary can be used to perform very rapid separations.

Equation 1 is only useful for determining the apparent mobility. To calculate the actual mobility, the phenomenon of electroosmotic flow must be accounted for. To perform reproducible electrophoresis, the electroosmotic flow must be carefully controlled.

Electroosmosis

One of the fundamental processes that drive CE is electroosmosis. This phenomenon is a consequence of the surface charge on the wall of the capillary. The fused silica capillaries that are typically used for separations have ionizable silanol groups in contact with the buffer contained within the capillary. The pI of fused silica is about 1.5. The degree of ionization is controlled mainly by the pH of the buffer.

The electroosmotic flow (EOF) is defined by

$$v_{eo} = \frac{\epsilon \zeta}{4\pi\eta} E \quad (2)$$

where ϵ is the dielectric constant, η is the viscosity of the buffer, and ζ is the zeta potential measured at the plane of shear close to the liquid-solid interface.

The negatively-charged wall attracts positively-charged ions from the buffer, creating an electrical double layer. When a voltage is applied across the capillary, cations in the diffuse portion of the double layer migrate in the direction of the cathode, carrying water with them. The result is a net flow of buffer solution in the direction of the negative electrode. This electroosmotic flow can be quite robust, with a linear velocity around 2 mm/s at pH 9 in 20 mM borate. For a 50 μm i.d. capillary, this translates into a volume flow of about 4 nL/s. At pH 3 the EOF is much lower, about 0.5 nL/s.

The zeta potential is related to the inverse of the charge per unit surface area, the number of valence electrons, and the square root concentration of the electrolyte. Since this is an inverse relationship, **increasing the concentration of the electrolyte decreases the EOF.**

As we will see later on, the electroosmotic flow must be controlled or even suppressed to run certain modes of CE. On the other hand, the EOF makes possible the simultaneous analysis of cations, anions, and neutral species in a single analysis. At neutral to alkaline pH, the EOF is sufficiently stronger than the electrophoretic migration such that all species are swept towards the negative electrode. The order of migration is cations, neutrals, and anions.

The effect of pH on EOF is illustrated in Figure 2. Imagine that a zwitterion such as a peptide is being separated under each of the two conditions described in the figure. At high pH, EOF is large and the peptide is negatively charged. Despite the peptide's electrophoretic migration towards the positive electrode (anode), the EOF is overwhelming, and the peptide migrates towards the negative electrode (cathode). At low pH, the peptide is positively charged and EOF is very small. Thus, peptide electrophoretic migration and EOF are towards the negative electrode. In untreated fused silica capillaries **most solutes migrate towards the negative electrode regardless of charge** when the buffer pH is above 7.0. At acidic buffer pH, most zwitterions and cations will also migrate towards the negative electrode.

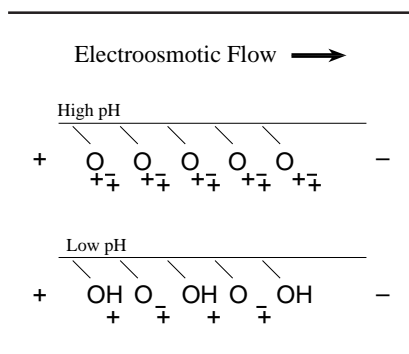

Figure 2. Effect of pH on the Electroosmotic Flow

To ensure that a system is properly controlled, it is often necessary to measure the EOF. This is accomplished by injecting a neutral solute and measuring the time it takes to reach the detector. Solutes such as methanol, acetone, and mesityl oxide are frequently employed. In the micellar electrokinetic capillary chromatography (MECC) technique to be discussed later, a further requirement that the marker solute not partition into the micelle is also imposed.

To perform techniques such as isoelectric focusing (IEF) or isotachopheresis (ITP), EOF must be suppressed. This is possible if an uncharged, *e.g.*, Teflon,¹ or a suitably coated capillary is used. Additives such as methylcellulose are also effective in suppressing EOF. EOF suppression will be discussed later.

¹ Teflon is a trademark of E.I. Du Pont de Nemours & Co.

Flow dynamics, efficiency, and resolution

When employing a pressure-driven system such as a liquid chromatograph, the frictional forces at the liquid-solid interfaces, such as the packing and the walls of the tubing, result in substantial pressure drops. Even in an open tube, the frictional forces are severe enough at low flow rates to result in **laminar** or **parabolic flow** profiles. As a consequence of parabolic flow, a cross-sectional flow gradient, shown in Figure 3, occurs in the tube, resulting in a flow velocity that is highest in the middle of the tube and approaches zero at the tubing wall. This velocity gradient results in substantial bandbroadening.

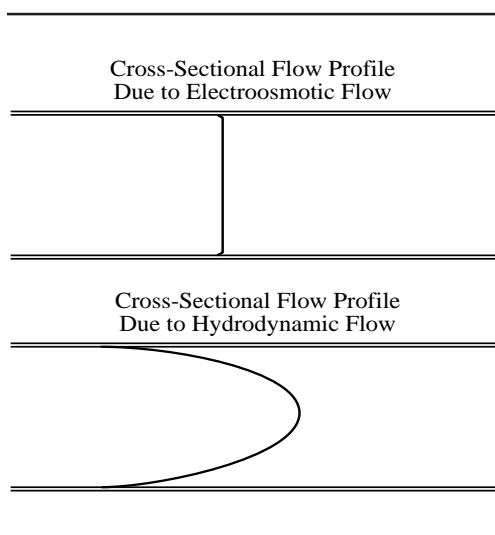

Figure 3. Capillary Flow Profiles

In electrically driven systems, the driving force of the EOF is uniformly distributed along the entire length of the capillary. As a result, there is no pressure drop and the flow velocity is uniform across the entire tubing diameter except very close to the wall where the velocity again approaches zero.

The efficiency of a system can be derived from fundamental principles. The migration velocity, v_{ep} , is simply

$$v_{ep} = \mu_{ep} E = \mu_{ep} \frac{V}{L} \quad (3)$$

The migration time, t , is defined as

$$t = \frac{L}{v_{ep}} = \frac{L^2}{\mu_{ep} V} \quad (4)$$

During migration through the capillary, molecular diffusion occurs leading to peak dispersion, σ^2 , calculated as

$$\sigma^2 = 2D_m t = \frac{2D_m L^2}{\mu_{ep} V} \quad (5)$$

where D_m = the solute's diffusion coefficient cm^2/s . The number of theoretical plates is given as

$$N = \frac{L^2}{\sigma^2} \quad (6)$$

Substituting the dispersion equation into the plate count equation yields

$$N = \frac{\mu_{ep} V}{2D_m} \quad (7)$$

The dispersion, σ^2 , in this simple system is assumed to be time-related diffusion only. The equation indicates that macromolecules such as proteins and DNA, which have small diffusion coefficients, D , will generate the highest number of theoretical plates. In addition, the use of high voltages will also provide for the greatest efficiency by decreasing the separation time. The practical voltage limit with today's technology is about 30 kV. The practical limit of field strength (one could use very short capillaries to generate high field strength) is **Joule heating**. Joule heating is a consequence of the resistance of the buffer to the flow of current. The problems of heat generation/dissipation will be covered shortly.

Substituting some numbers into the plate count equation using the protein horse heart myoglobin (MW 13,900) as an illustration, where $\mu_{ep} = 0.65 \times 10^{-4} \text{ cm}^2/\text{Vs}$ (20 mM bicine/TEA buffer, pH 8.5) and $D_m = 1 \times 10^{-6} \text{ cm}^2/\text{s}$ at 30,000 V, gives a plate count of 975,000 theoretical plates.

In spite of the diffusional limitation, CE is still useful for small-molecule separations because μ_{ep} is a function of the charge-to-mass ratio. Small molecules tend to be more mobile. For example, the mobility of quinine sulfate is 4×10^{-4} cm²/Vs. Despite the higher diffusion coefficient of 0.7×10^{-5} cm²/s, the equation solves for $N = 857,000$ theoretical plates when $V = 15,000$ volts.

The resolution, R_s , between two species is given by the expression

$$R_s = \frac{1}{4} \frac{\Delta\mu_{ep}}{\bar{\mu}_{ep}} \sqrt{N} \quad (8)$$

where $\Delta\mu_{ep}$ is the difference in electrophoretic mobility between the two species, $\bar{\mu}_{ep}$ is the average electrophoretic mobility of the two species and N is the number of theoretical plates. If we substitute the plate count equation, we get

$$R_s = (0.177) \frac{\mu_{ep} \sqrt{V}}{\bar{\mu}_{ep} \sqrt{D_m}} \quad (9)$$

This expression indicates that increasing the voltage is a limited means of improving resolution. To double the resolution, the voltage must be quadrupled. The key to high resolution is to increase $\Delta\mu_{ep}$. The control of mobility is best accomplished through selection of the proper mode of capillary electrophoresis coupled with selection of the appropriate buffers. Both of these areas will be covered later in this book.

Capillary diameter and Joule heating

The production of heat in CE is the inevitable result of the application of high field strengths. Two major problems arise from heat production: temperature gradients across the capillary and temperature changes with time due to ineffective heat dissipation.

The rate of heat generation in a capillary can be approximated as follows

$$\frac{dH}{dt} = \frac{iV}{LA} \quad (10)$$

where L is the capillary length and A , the cross-sectional area. Since $i = V/R$ and $R = L/kA$ where k is the conductivity, then

$$\frac{dH}{dt} = \frac{kV^2}{L^2} \quad (11)$$

The amount of heat generated is proportional to the square of the field strength. Either decreasing the voltage or increasing the length of the capillary has a dramatic effect on the heat generation. The use of low-conductivity buffers is also helpful in this regard although sample loading is adversely affected.

Temperature gradients across the capillary are a consequence of heat dissipation. Since heat is dissipated by diffusion, it follows that the temperature at the center of the capillary should be greater than at the capillary walls.

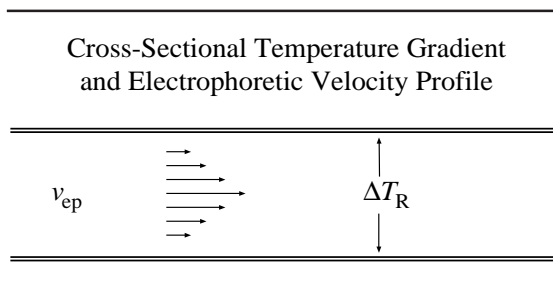

Figure 4. Cross-Sectional Thermal Gradient and the Electrophoretic Velocity Profile

Since viscosity is lower at higher temperatures, it follows that both the EOF and electrophoretic mobility (EPM) will increase as well. Mobility for most ions increases by 2% per degree kelvin. The result is a flow profile that resembles hydrodynamic flow, and bandbroadening occurs. Operating with narrow-diameter capillaries improves the situation for two reasons: the current passed through the capillary is reduced by the square of the capillary radius, and the heat is more readily dissipated across the narrower radial path. The resulting thermal gradient is proportional to the square of the diameter of the capillary, which can be approximated from the following equation

$$\Delta T = 0.24 \frac{Wr^2}{4K} \quad (12)$$

where W is the power, r is the capillary radius, and K , the thermal conductivity.

The second problem is ineffective heat dissipation. If heat is not removed at a rate equal to its production, a gradual but progressive temperature rise will occur until equilibrium is reached. Depending on the specific experimental conditions, imprecision in migration time will result due to variance in both EOF and electrophoretic velocity. Narrow-diameter capillaries help heat dissipation, but effective cooling systems are required to ensure heat removal. Liquid cooling is the most effective means of heat removal and capillary temperature control.

Capillary inner diameters range from 20-200 μm . From the standpoint of resolution, the smaller the capillary i.d., the better the separation. However, smaller-bore capillaries yield poorer limits of detection due to reduced detector path length and sample loadability. Narrow capillaries are also more prone to clogging. As long as buffers are filtered through <0.5- μm filters, clogging is seldom a problem in the above mentioned size range. Since it may be impractical to filter samples, high speed centrifugation is usually sufficient to settle suspended particles.

Effects of voltage and temperature

Both the electroosmotic and electrophoretic velocities are directly proportional to the field strength, so the use of the highest voltages possible will result in the shortest times for the separation. Theory predicts that short separation times will give the highest efficiencies since diffusion is the most important feature contributing to bandbroadening. The limiting factor here is Joule heating. Experimentally, the optimal voltage is determined by performing runs at increasing voltages until deterioration in resolution is noted.

The electrophoretic mobility (Eq. 13) and the electroosmotic flow (Eq. 2) expressions both contain a viscosity term in the denominator. Viscosity is a function of temperature; therefore, precise temperature control is important. As the temperature increases, the viscosity decreases; thus, the electrophoretic mobility increases as well. Some buffers such as Tris are known to be pH-sensitive with temperature. For complex separations such as peptide maps, even small pH shifts can alter the selectivity.

Most separations are performed at 25°C (*i.e.*, near room temperature). With liquid cooling of the capillary it is possible to maintain excellent temperature control, even with high-concentration buffers and large-bore capillaries. Whenever temperature control starts to become a problem, the usual strategy is to use a smaller-bore capillary (less current reduces the heat produced) or a longer capillary (more surface area dissipates the heat generated). An alternative is to reduce the buffer concentration, but this also reduces peak efficiency by decreasing the focusing effect. Inadequate temperature control is the main reason for using low-concentration (*e.g.*, 20 mM) buffers or operating at elevated temperatures.

Modes of capillary electrophoresis

Capillary electrophoresis comprises a family of techniques that have dramatically different operative and separative characteristics. The techniques are:

- Capillary zone electrophoresis
- Isoelectric focusing
- Capillary gel electrophoresis
- Isotachopheresis
- Micellar electrokinetic capillary chromatography

Each of these modes of CE will be covered in the following sections. Other less mature modes of electrophoresis such as electroosmotic chromatography will not be covered here.

Capillary zone electrophoresis

Capillary zone electrophoresis (CZE), also known as free solution capillary electrophoresis, is the simplest form of CE. The separation mechanism is based on differences in the charge-to-mass ratio. Fundamental to CZE are **homogeneity of the buffer solution** and **constant field strength** throughout the length of the capillary.

Following injection and application of voltage, the components of a sample mixture separate into discrete zones as shown in Figure 5. The fundamental parameter, electrophoretic mobility, μ_{ep} , can be approximated from Debye-Huckel-Henry theory

$$\mu_{ep} = \frac{q}{6\pi\eta R} \quad (13)$$

where q is the net charge, R is the Stokes radius, and η is the viscosity. In practice, analytical chemists infrequently calculate electrophoretic mobilities, although some understanding of the parameters describing the phenomenon is useful.

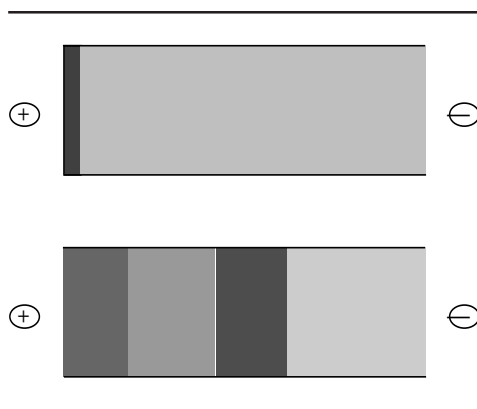

Figure 5. Capillary Zone Electrophoresis

The net charge is usually pH dependent. For example, within the pH range of 4-10, the net charge on sodium is constant as is its mobility. Other species such as acetate or glutamate are negatively charged within that pH range and thus have negative mobilities (they migrate towards the positive electrode). At alkaline pH, their net migration will still be towards the negative electrode because of the EOF. Zwitterions such as amino acids, proteins, and peptides exhibit charge reversal at their pI's and, likewise, shifts in the direction of electrophoretic mobility.

Separations of both large and small molecules can be accomplished by CZE. Even small molecules, where the charge-to-mass ratio differences may not be great, may still be separable.

Capillaries. Capillaries with an internal diameter of 25-75 μm are usually employed. Fused silica is the material of choice due to its UV transparency, durability (when polyimide coated), and zeta potential. Functionalized and gel-filled capillaries are becoming available and will be covered in other sections.

A new capillary must be conditioned before it can be used. Pretreat the capillary for 10 min with 0.1 M sodium hydroxide, 5 min with water, and 10 min with run buffer. This conditioning procedure is important to ensure that the surface of the capillary is fully and uniformly charged. For some methods it is necessary to regenerate this surface between runs with 0.1 M sodium hydroxide, and in extreme cases, 1 M sodium hydroxide. The regeneration procedure is frequently necessary if migration times change on a run-to-run basis. This is most common when using buffers in the pH 2-6

region. Regeneration is seldom necessary when working above pH 9 except as a daily startup procedure unless sample or matrix components are adhering to the capillary walls.

Not all attempts to store a fused silica capillary are successful. The smaller the capillary i.d., the more prone it is to clogging. While this is not too serious for bare silica, capillary damage can be costly when using chemically modified capillaries. The following procedure will maximize your chances of successfully storing a capillary.

- 1) Rinse the capillary with 0.1 M NaOH for a few minutes. (Do not do this with chemically-modified capillaries.)
- 2) Rinse for 5 min with distilled water.
- 3) Place an empty, uncapped vial at the outlet end and blow N₂ through the capillary for 5 min.
- 4) Remove the capillary cartridge from the instrument.

Effect of pH. At a high pH where EOF is substantial, the order of migration will be cations, neutrals, and anions. None of the neutral molecules will be separated since the net charge is zero. The anions will still migrate toward the cathode because the EOF is greater than the electrophoretic migration.

At lower pH where the EOF is greatly reduced, both cations and anions can still be measured, although not in a single run. To measure anions, the anode must be beyond the detector window. Likewise, to measure cations, the cathode must reside beyond the detector window. The proper electrical configuration is achieved by simply reversing the polarity of the electrodes.

The impact of pH on the analyte can also be substantial, particularly for complex zwitterionic compounds such as peptides. The charge on these compounds is pH-dependent, and the selectivity of separation is affected substantially by pH. As a rule of thumb, select a pH that is at least two units above or below the pK_a of the analyte to ensure complete ionization. At highly alkaline pH, the EOF may be so rapid that incomplete separations may occur.

Certain protein separations can be performed at acidic pH. Under these conditions, the capillary wall is uncharged. The proteins under these conditions will be positively charged and will not electrostatically interact with the wall, although hydrophobic interaction may still occur. The limitation of this technique is protein precipitation. At the pI of the protein, band symmetry tends to be poor.

Buffers. A wide variety of buffers (Table 1) can be employed in CZE. A buffer is most effective within one or two pH units of its pI. For example, phosphate is used around pH 2.5 and pH 7, and borate around pH 9. The typical buffer concentration is 50-100 mM.

Zwitterionic buffers such as bicine, tricine, CAPS, MES, and Tris are also common, particularly for protein and peptide separations. The advantage of the zwitterionic buffer is its low conductivity when the buffer is employed around the pI. The advantage therein is the low current draw and thus reduced Joule heating. In certain buffer preparations, particularly those directed at protein separations, salts such as chloride, phosphate, and sulfate are added to the buffer medium. These added salts affect the conformation of the protein, which in turn can impact the separation. The salt concentration also impacts the EOF due in part to disruption of the charged double layer at the walls of the capillary. The major limitation on the amount of salt that can be added to a buffer preparation is Joule heating.

Table 1. Buffers for Capillary Electrophoresis

Buffer	Useful pH Range
Phosphate	1.14 - 3.14
Acetate	3.76 - 5.76
Phosphate	6.20 - 8.20
Borate	8.14 - 10.14
Zwitterionic Buffers	
MES	5.15 - 7.15
PIPES	5.80 - 7.80
HEPES	6.55 - 8.55
Tricine	7.15 - 9.15
Tris	7.30 - 9.30

Various buffer additives (Table 2) can be employed to change the selectivity of the separation. Buffer additives can alter, among other things, electrophoretic mobilities. In other words, two compounds that have identical mobilities in a simple buffer system may be differentiated with an additive. Other additives, such as surfactants or cyclodextrins, form a heterogeneous environment that defines new classes of CE that will be covered later.

All buffers should be filtered through 0.45- μ m filters prior to use.

Table 2. Buffer Additives for CZE

Additive	Function
Inorganic salts	Protein conformational changes
Organic solvents	Solubilizer, modify electroosmotic flow
Urea	Solubilize proteins and denature oligonucleotides
Sulfonic acids	Ion pairing agents, hydrophobic interaction agents
Cationic surfactants	Charge reversal of capillary wall
Cellulose derivatives	Reduce electroosmotic flow, provide a sieving medium
Amines	Cover free silanol groups

Capillary wall binding. One problem with CZE is electrostatic binding of cationic substances to the walls of the tubing. This effect is observed with proteins when operating in a buffer that has a pH below the pK_a of the analyte. This problem can be overcome by operating at least two pH units above the pK_a of the protein, but in some cases, the higher pH may not be optimal for the separation. In spite of these problems, proteins, especially those of similar size, can be best separated in free solution. The use of treated capillaries is one of several ways that can serve to reduce wall binding.

Another recently developed procedure involves the use of high-concentration phosphate buffer to screen the charge on the inner capillary wall and short (20 cm), small-bore (25 μm) capillaries operated at high electric field strengths which allow for very rapid separations, thereby minimizing the residence time of the proteins in the capillary. This approach does require an excellent capillary temperature control system in order to remove the heat generated by the high voltages and currents.

Capillary coating. The reduction of or elimination of EOF can be useful to enable direct electrophoretic separations to be performed. More compelling is the ability to eliminate solute adsorption. A variety of coatings is possible including some phases used for capillary gas chromatography. The use of hydrophilic coatings can be useful in suppressing adsorption of hydrophobic compounds. Electrostatic binding can also be suppressed. Hydrophobic coatings, in conjunction with nonionic surfactants as buffer additives, appear promising as well. Many companies are beginning to introduce bonded-phase capillaries. These capillaries should further extend the range of compounds applicable to separation by CZE.

Applications. CZE is very useful for the separation of proteins and peptides since complete resolution can often be obtained for analytes differing by only one amino acid substituent. This is particularly important in tryptic mapping where mutations and post-translational modifications must be detected. Figure 6 illustrates the separation of a tryptic digest of reduced, denatured and alkylated bovine serum albumin (BSA). The separation is run at low pH with 1.5 M urea as an additive. The urea induces peptide unfolding, thereby exposing the internal structural elements.

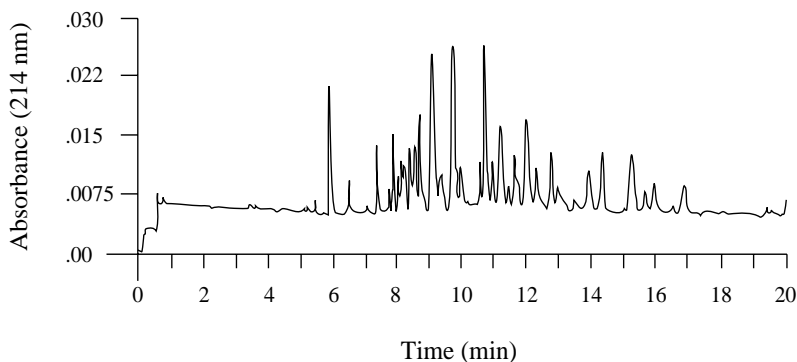

Figure 6. CZE Separation of a Tryptic Digest of Reduced, Denatured and Alkylated Bovine Serum Albumin. Buffer, 21 mM sodium phosphate (monobasic), 1.5 M urea, pH 2.5; capillary, 59 cm. Courtesy of R. Rush, A. Cohen, and B. Karger, Northeastern University.

Other applications where CZE may be useful include inorganic anions and cations such as those typically separated by ion chromatography. Small molecules such as pharmaceuticals can often be separated provided they are charged. In most cases, the technique of micellar electrokinetic capillary chromatography gives superior results for charged as well as neutral small molecules. This mode of CE will be covered later.

A summary of applications including the buffer recipe and reference is given in Table 3.

Table 3. Applications of CZE

Analyte	Buffer	Reference
Dipeptides/proteins	150 mM H ₃ PO ₄ , pH 1.5	<i>Anal. Chem.</i> 60, 2322 (1988)
Angiotensin II octapeptides	150 mM NaH ₂ PO ₄ , pH 3.0	<i>Anal. Chem.</i> 60, 2322 (1988)
Tryptic digest	12.5 mM phosphate, pH 6.86	<i>J. Chromatogr.</i> 352, 337 (1986)
β-Lactoglobulin	50 mM borate, 50 mM KCl	<i>J. Chromatogr.</i> 447, 117 (1988)
Carbonic anhydrase		
Whale skeletal myoglobin		
Myoglobins	10 mM tricine, 40 mM KCl, pH 8.24	<i>Anal. Chem.</i> 58, 743a (1986)
Carbonic anhydrases		
β-Lactoglobulins		
Horse heart myoglobin	10 mM borate, 40 mM KCl, pH 9.5	<i>J. Chromatogr.</i> 480, 157 (1989)
Endorphins	20 mM citrate, pH 2.5	<i>Anal. Chem.</i> 61, 1186 (1989)
Ribonucleases	20 mM CAPS, pH 11.0	<i>Anal. Chem.</i> 61, 1186 (1989)
Immune complexes	0.1 M tricine, pH 8.0	<i>Anal. Chem.</i> 61, 1186 (1989)
Tobacco mosaic virus	2 mM potassium borate	<i>Anal. Chem.</i> 62, 1592 (1990)
Adenosine-5' [α- ³² P]triphosphate	200 mM borate, pH 8.1	<i>J. Chromatogr.</i> 480, 259 (1989)
Lysozyme, α-chymotrypsin	0.1 M CHES, 0.25 M K ₂ SO ₄ , pH 9	<i>J. Chromatogr.</i> 480, 301 (1989)
Nucleoside phosphates	40 mM glutamic acid/GABA	<i>J. Chromatogr.</i> 480, 321 (1989)
Collagens	2.5 mM sodium tetraborate	<i>J. Chromatogr.</i> 480, 371 (1989)
Membrane proteins	0.2 M borate, 7 M urea, pH 9.2	<i>J. Chromatogr.</i> 516, 89 (1990)
Human growth hormone	100 mM phosphate, pH 2.6, pH 8	<i>J. Chromatogr.</i> 480, 379 (1989)
Anions	25 mM salicylate, pH 4	<i>J. Chromatogr.</i> 480, 169 (1989)

Isoelectric focusing

The fundamental premise of isoelectric focusing (IEF) is that a molecule will migrate so long as it is charged. Should it become neutral, it will stop migrating in the electric field. IEF is run in a pH gradient where the pH is low at the anode and high at the cathode (Figure 7). The pH gradient is generated with a series of zwitterionic chemicals known as **carrier ampholytes**. When a voltage is applied, the ampholyte mixture separates in the capillary. Ampholytes that are positively charged will migrate towards the cathode while those negatively charged migrate towards the anode. The

pH then will decrease at the anodic section and increase at the cathodic section. Finally, the ampholyte migration will cease when each ampholyte reaches its isoelectric point and is no longer charged. Initially, a solute with a net negative charge will migrate towards the anode where it encounters buffer of decreasing pH. Finally, the solute encounters a pH where its net charge becomes zero, the isoelectric point (pI), and migration halts. The greater the number of ampholytes in solution, the smoother the pH gradient.

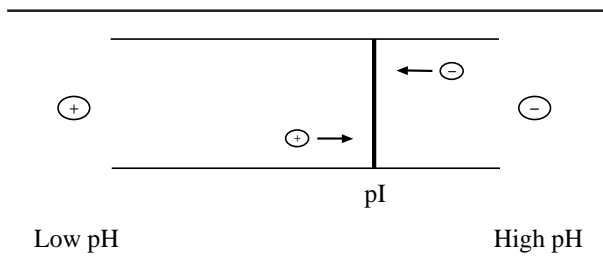

Figure 7. Isoelectric Focusing

The pH of the anodic buffer must be lower than the pI of the most acidic ampholyte to prevent migration into the **analyte**. Likewise, the **catholyte** must have a higher pH than the most basic ampholyte.

It is apparent that the EOF and other convective forces must be suppressed if IEF is to be effective. The capillary walls can be coated with methylcellulose or polyacrylamide to suppress EOF. The coating tends to suppress protein adsorption as well. IEF is generally used for high resolution separations of proteins and polypeptides but could be used for any amphoteric substance, provided a series of ampholytes that cover the entire pI range is used.

Resolving power. The resolving power, ΔpI , of IEF is described by the equation

$$\Delta pI = 3 \sqrt{\frac{D(dpH/dx)}{E(d\mu/dpH)}} \quad (14)$$

where D is the diffusion coefficient, E is the electric field strength, and μ is the electrophoretic mobility of the protein. A resolving power of 0.02 pH units has been calculated.

The three basic steps of IEF are loading, focusing, and mobilization. In traditional slab-gel techniques, the mobilization technique is unnecessary.

Once focusing is complete, the gel is stained using traditional methods. In capillary IEF, the bands must migrate past the detector, so the mobilization step becomes necessary. In contrast to CZE, the buffer medium is discontinuous, *i.e.*, a pH gradient is formed along the capillary. Commercial ampholytes are available from several suppliers covering many pH ranges. Broad-range buffers are used to estimate the pI. Then a narrower pH range can be employed to improve precision. A series of calibrants of known pI's are employed to correlate the migration time with the isoelectric point.

Loading. The sample is mixed with the appropriate ampholytes (available from Bio-Rad or Pharmacia) to a final concentration of 1-2% ampholytes. The mixture is loaded into the capillary either by pressure or vacuum aspiration.

Focusing. The buffer reservoirs are filled with sodium hydroxide (cathode) and phosphoric acid (anode). Field strengths on the order of 500-700 V/cm are employed. As the focusing proceeds, the current drops to less than 1 μ A. Overfocusing can result in precipitation due to protein aggregation at high localized concentrations. Dispersants such as nonionic surfactants (Triton X-100 or Brij-35), or organic modifiers such as glycerol or ethylene glycol may minimize aggregation. These agents are mild and usually do not denature the protein. Urea could also be used, but the protein will become denatured. Because of precipitation problems, very hydrophobic proteins are not usually separated by IEF. Gel-filled capillaries are sometimes useful for separating troublesome proteins.

Mobilization. Mobilization can be accomplished in either the cathodic or anodic direction. For cathodic mobilization, the cathode reservoir is filled with sodium hydroxide/sodium chloride solution. In anodic mobilization, the sodium chloride is added to the anode reservoir. The addition of salt alters the pH in the capillary when the voltage is applied since the anions/cations compete with hydroxyl/hydronium ion migration. As the pH is changed, both ampholytes and proteins are mobilized in the direction of the reservoir with added salt. As mobilization proceeds, the current rises as the saline ions migrate into the capillary. Detection is performed at 280 nm for proteins since the ampholytes absorb strongly in the low UV range.

Applications. In addition to performing high resolution separations, IEF is useful for determining the pI of a protein. IEF is particularly useful for separating immunoglobulins, hemoglobin variants and post-translational modifications of recombinant proteins. A separation of a protein mixture is shown in Figure 8.

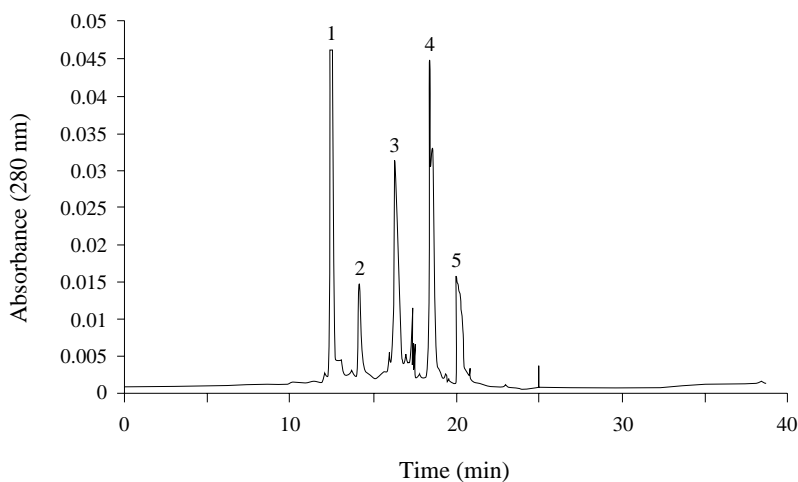

Figure 8. Separation of a Protein Mixture by IEF. Ampholyte pH range, 3.5-10; catholyte, 50 mM sodium hydroxide; analyte, 150 mM phosphoric acid; voltage, 25 kV; mobilization (catholyte), 50 mM sodium chloride, 50 mM sodium hydroxide. Courtesy of R. Nelson and B. Karger, Northeastern University.

Capillary gel electrophoresis

Traditional gel electrophoresis is conducted in an anticonvective medium such as polyacrylamide or agarose. The composition of the media can also serve as a molecular sieve to perform size separations (Figure 9). Furthermore, the gel suppresses the EOF. Because of the long history of this technique, the adaptation to CE is very desirable. This is particularly valuable for DNA separations since no other technique to date has provided such dramatic separations. Commercial capillary gel columns are now beginning to be introduced to the marketplace from numerous sources. Polyacrylamide gel-filled capillaries are usually employed, although new polymer formulations with greater stability to the applied electric field are likely to be introduced shortly. Agarose gels are unable to withstand the heating produced by the high voltages used in capillary gel electrophoresis (CGE).

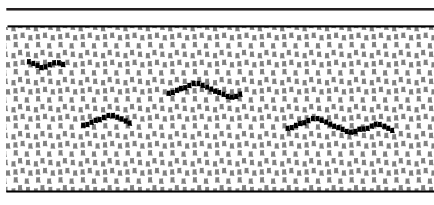

Figure 9. Capillary Gel Electrophoresis

There are two fundamental classes of gels that can be employed in CGE. These are illustrated in Figure 10. The **physical gel** obtains its porous structure by entanglement of polymers and is quite rugged to changes in the environment. Hydroxypropylmethylcellulose and similar polymers can be used to form physical gels. **Chemical gels** use covalent attachment to form the porous structure. These gels are less rugged, and it is difficult to change the running buffers once the gels are formed. In CZE and other forms of “open-tubular” CE, the capillary is filled with buffer by pressurization. For gel-filled capillaries, this technique would result in extrusion of the gel. Urea and other buffer agents such as Tris-borate-EDTA are added prior to polymerization. Cross-linked polyacrylamide is usually selected as the gel-forming agent.

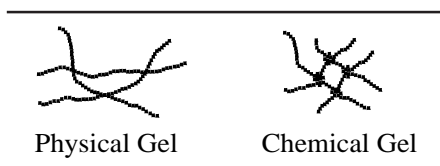

Figure 10. Physical and Chemical Gels

CGE is typically performed in 50- to 100- μm capillaries in lengths of about 10 cm to 1 m. Better resolution is found for the longer capillaries, but the run times are excessive. The capillary gel composition is better manipulated to optimize the resolution. For example, increasing the gel concentration improves resolution but decreases the molecular weight range accessible within the run. The voltage is somewhat limiting since field strengths above 500 V/cm may cause capillary heating and, ultimately, voids.

Proteins. Proteins denatured with 2-mercaptoethanol are usually run with an SDS-PAGE system. Under these conditions, all proteins have the same charge-to-mass ratio since the native charge is obscured by SDS binding.

Indeed, a constant amount of SDS, 1.4 g, is adsorbed onto each gram of protein. SDS is anionic; therefore, all proteins become negatively charged and migrate towards the anode. Proteins unfold (provided disulfide linkages are broken) and become rod-like in structure allowing uniform molecular sieving for size separation. A typical buffer is 90 mM Tris-phosphate, pH 8.6, 0.1% SDS. A calibration plot of mobility versus molecular weight permits size assignments of the various fragments. Electrokinetic injections are used in CGE since pressure-mediated injection would result in extrusion of the gel. Short 10-20 cm capillaries are employed with field strengths approaching 400 V/cm. Under these conditions, there is a linear correlation between mobility and molecular weight. The log of the mobility versus the percent monomer composition (%T) of the gel is also linear. Proteins are usually denatured in 1% SDS and 2% β -mercaptoethanol for 30 min at 90°C.

As in conventional slab-gel electrophoresis, the migration times decrease as the pore size increases (lower %T). Separation times can also be reduced by using higher voltages, provided heat dissipation is adequate. Short capillaries can also be used at the same field strength to further speed the separation.

DNA. Separation of oligonucleotides and DNA sequence products have been accomplished in polyacrylamide gels. For restriction fragments and larger oligos, gels with little or no crosslinker seem most effective due to the larger pore size of the gel. Separation of deoxyoligonucleotides such as poly(dA)₄₀₋₆₀ is readily accomplished in an 8% T gel with a buffer consisting of 100 mM Tris-borate, pH 8.3 with 2 mM EDTA and 7 M urea, in under 35 min with unit base resolution. Determining the purity of synthetic oligos is an important application of CGE. Figure 11 shows the separation of a synthetic 50-mer homopolymer of thymidine with modulo 5 enhancement. The failure sequences are well separated with unit base resolution.

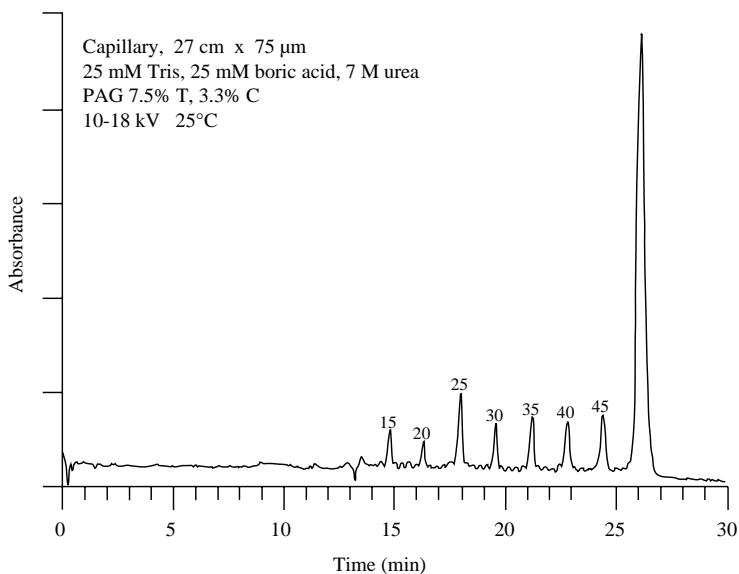

Figure 11. CGE of Thymidine Synthetic Homopolymer with Modulo 5 Enhancement. Buffer, 25 mM Tris, 25 mM boric acid, 7 M urea; gel, polyacrylamide, 7.5% T, 3.3% C. Courtesy of A. Paulus and J. Ohms, Beckman Instruments, Inc.

Double-stranded DNA can be separated with physical gels. Surface modified capillaries are best employed since the electroosmotic flow is totally suppressed. Under these conditions, the fragment migration time is directly related to the number of bases present. Figure 12 shows the separation of a Hae III restriction digest of ϕ X174 DNA. These separations are very efficient as the peak representing 118 base pairs yields about 2,000,000 theoretical plates per meter. The use of ethidium bromide as a buffer additive enhanced the separation, permitting good resolution of the peaks representing 261 and 271 base pairs. The resolution of this system is 3 base pairs. Among the other useful applications for this system are separations of PCR-amplified DNA as well as restriction digests.

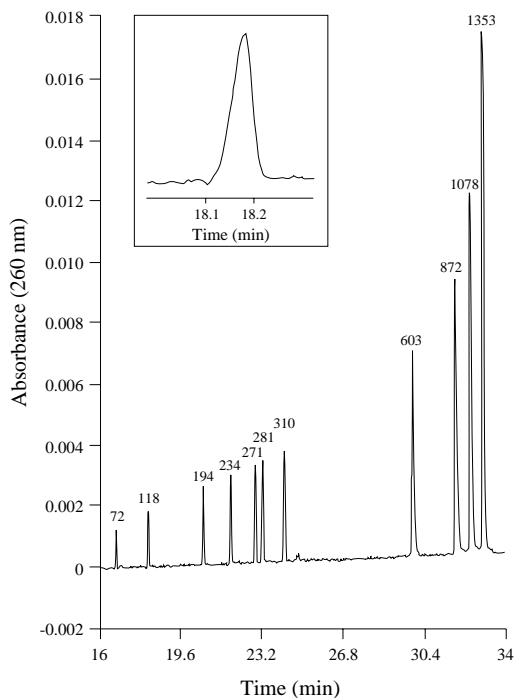

Figure 12. Separation of Hae III Restriction Digest of ϕ X174 DNA by CGE with a Physical Gel. Buffer, 89 mM Tris-borate, 2 mM EDTA, pH 8.5, 0.5% hydroxypropylmethylcellulose, 10 μ M ethidium bromide; capillary, DB-17 coated, 100 μ m \times 50 cm (length to detector); field strength, 175 V/cm; detection, 260 nm; sample concentration, 10 μ g/mL.

Capillary gel electrophoresis is still in its infancy. While most academic labs are manufacturing their own capillaries either by covalent bonding of polyacrylamide to the capillary walls or packing the capillaries with the gels, it is expected that most users will purchase capillaries from commercial vendors. Likewise, optimized buffer solutions for separating DNA in the physical gel format are also being provided by manufacturers. One of

the many driving forces for the development of gel-filled capillaries is DNA sequencing. The hope is that a multiplex CE instrument with gels will form the basis of a genomic scale instrument.

Isotachopheresis

Prior to 1981, isotachopheresis (ITP) was the most widely used instrumental capillary electrophoretic technique, although the capillaries were quite wide (250-500 μm) by today's standards. A commercial instrument, the LKB Tachophor, was introduced in the mid-1970s.

Like IEF, ITP relies on zero electroosmotic flow, and the buffer system is heterogeneous. The capillary is filled with a **leading electrolyte** that has a higher mobility than any of the sample components to be determined. Then the sample is injected. A **terminating electrolyte** occupies the opposite reservoir, and the ionic mobility of that electrolyte is lower than any of the sample components. Separation will occur in the gap between the leading and terminating electrolytes based on the individual mobilities of the analytes. As shown in Figure 13, stable zone boundaries form between individual components resulting in highly efficient separations. Both anions and cations could be determined, though not in the same run.

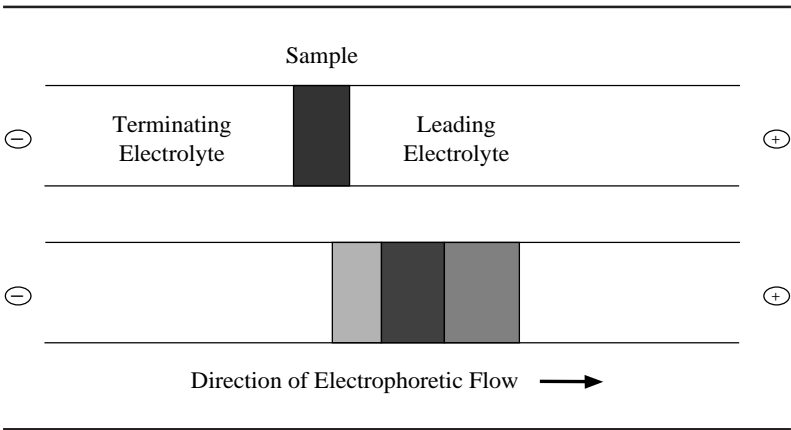

Figure 13. Anionic Isotachopheresis

In the early instrumentation, detection was by conductivity or differential conductivity. Conductivity detection gave a stair-step pattern as each individual ion passed the electrodes. Differential conductivity could restore the isotachopherogram to a series of conventional peaks. Direct UV detec-

tion also gives a more familiar looking electropherogram in the presence of **spacers**. A spacer is a nonabsorbing solute with a mobility value that falls in between the mobilities of two peaks that need to be resolved. The disadvantage of ITP is that unless spacers are employed, adjacent bands are in contact with each other. A second problem is that, compared to CZE, the selection and optimization of the buffer are less straight forward. For example, to determine cations, the leading cathodic electrolyte might contain highly mobile acid (H^+) while the terminating anodic electrolyte might contain a weaker acid such as propionic acid. Most of these points are illustrated in Figure 14 for ITP of some anions. The lower plot is the direct conductivity (plotted as resistance) tracing while the upper plot represents differential conductivity.

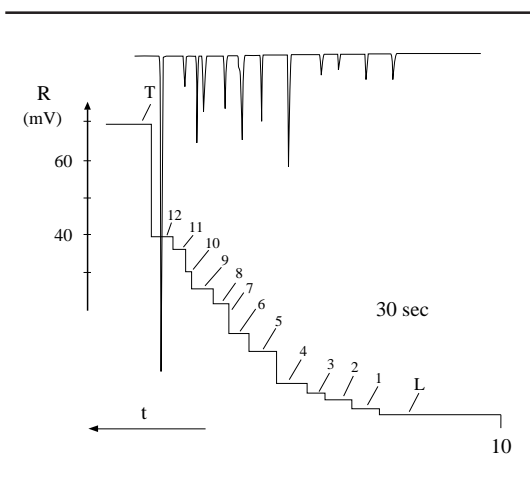

Figure 14. ITP of a Mixture of Anions with Conductivity Detection. Capillary, 105 μm i.d. fluorinated ethylene-propylene copolymer; leader, 10 mM hydrochloric acid titrated to pH 6.0 with histidine, 2 mM hydroxyethylcellulose; terminator, 5 mM MES; driving current, 10 μA . Key: R, signal on conductivity meter (increasing resistance); L, chloride; 1, sulfate; 2, chlorate; 3, chromate; 4, malonate; 5, adipate; 6, benzoate; 7, impurity; 8, acetate; 9, β -bromopropionate; 10, naphthalene-2-sulfonate; 11, glutamate; 12, enantate; T, MES. Reproduced in part from J. Chromatogr., 267, 67 (1983) (Fig. 3).

Isotachopheresis has two characteristics, the combination of which is unique to electrophoretic methods: all bands move at the same velocity, and the bands are focused. For example, highly mobile bands have high conductivity, and as a result, have a lower voltage drop across the band. Since the mobility is the product of the conductivity and the voltage drop, and conductivity and voltage drop are inversely proportional, the individual band velocities are self-normalizing. Focusing is also a consequence of velocity normalization. For example, if a band diffuses into a neighboring zone, it will either speed up or slow down based on the field strength encountered and rejoin the original band.

Operating on modern instrumentation has been successful, both with treated and untreated fused silica capillaries. EOF can be suppressed with 0.25% hydroxypropylmethylcellulose. A good leading electrolyte is 5 mM phosphoric acid. Valine (100 mM, adjusted to an appropriate pH with a primary amine) is a useful terminating electrolyte. At the start of a separation, the current may be quite high since the highly mobile electrolyte completely fills the capillary. As the separation progresses, the current always declines as the less mobile terminator enters the capillary.

There have been some recent publications that employ ITP as a pre-concentration step for CZE. Because ITP is a focusing technique, the use of large-diameter capillaries does not cause resolution to deteriorate the way it does for CZE.

Micellar electrokinetic capillary chromatography

Perhaps the most intriguing mode of CE for the determination of small molecules is MECC. The use of micelle-forming surfactant solutions can give rise to separations that resemble reverse-phase LC with the benefits of CE. Unlike IEF or ITP, MECC relies on a robust and controllable EOF.

Micelles. Micelles are amphiphilic aggregates of molecules known as **surfactants**. They are long chain molecules (10-50 carbon units) and are characterized as possessing a long hydrophobic tail and a hydrophilic head group. Normal micelles are formed in aqueous solution with the hydrophobic tails pointing inward and the hydrophilic heads pointing outward into the aqueous solution. A schematic is shown in Figure 15. Micelles form as a consequence of the hydrophobic effect, that is, they form to reduce the free energy of the system. The hydrophobic tail of the surfactant cannot be solvated in aqueous solution. Above a surfactant concentration known as the critical micelle concentration (CMC), the aggregate is fully formed. Physical changes such as surface tension, viscosity, and the ability to scatter

light accompany micelle formation. Reverse micelles, which form in organic solvents, have not been studied in MECC.

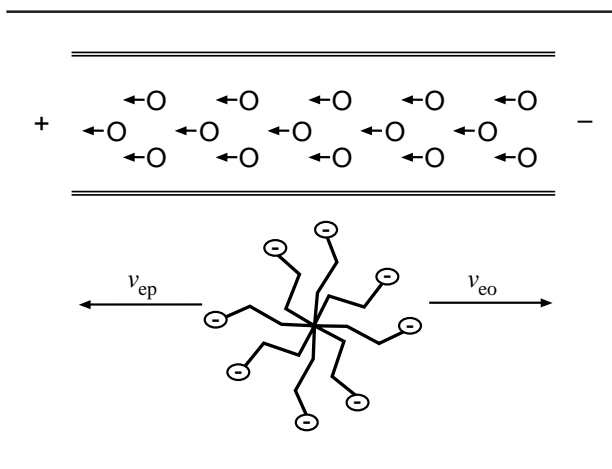

Figure 15. Micellar Electrokinetic Capillary Chromatography

There are four major classes of surfactants: anionic, cationic, zwitterionic, and nonionic, examples of which are given in Table 4. Of these four, the first two are most useful in MECC. Both synthetic and naturally occurring compounds have been employed for MECC. Synthetic varieties include anionic SDS and cationic cetyltrimethylammonium bromide (CTAB). Naturally occurring compounds such as bile salts (sodium taurocholate, etc.) are also useful.

Table 4. Surfactant Classes and Properties

Surfactant	Type	CMC	Aggregation #
SDS	Anionic	8.1×10^{-3}	62
CTAB	Cationic	9.2×10^{-4}	170
Brij-35	Nonionic	1.0×10^{-4}	40
Sulfobetaine	Zwitterionic	3.3×10^{-3}	55

SDS = sodium dodecyl sulfate; CTAB = cetyltrimethylammonium bromide; Brij-35 = polyoxyethylene-23-lauryl ether; sulfobetaine = *N*-dodecyl-*N,N*-dimethylammonium-3-propane-1-sulfonic acid.

SDS is the most widely used surfactant in MECC. It is available in highly purified forms and is inexpensive. Its molecular weight is 288 and the CMC is 8 mM. The aggregation number (number of molecules/micelle) is 62.

Micelles have the ability to organize analytes at the molecular level based on hydrophobic and electrostatic interactions. Even neutral molecules can bind to micelles since the hydrophobic core has very strong solubilizing power. Surfactant solutions have been employed in spectroscopy and chromatography to take advantage of these unique micellar properties. For example, room temperature phosphorescence is readily observable in micellar media since the micellar environment prevents many of the normal quenching mechanisms from operating. More significantly with regard to MECC, these same surfactant solutions can serve as chromatographic mobile phase modifiers. Micellar chromatography can mimic reverse-phase LC in that increasing the surfactant concentration increases the eluting power of the mobile phase. The analyte can partition between the micelle and the bulk phase, the micelle and the stationary phase, or the bulk and stationary phase. Thus, “pseudophase” or micellar LC has more complex equilibria than conventional LC. This three-phase equilibrium can be likened to ion-pair chromatography in many instances. In certain aspects, the mechanism of MECC, because of only a two-phase equilibrium, is simpler than micellar chromatography. The complicating factor in MECC is that analyte electrophoretic mobility often contributes to the overall separation.

Separation mechanism. At neutral to alkaline pH, a strong EOF moves in the direction of the cathode. If SDS is employed as the surfactant, the electrophoretic migration of the anionic micelle is in the direction of the anode (Figure 15). As a result, the overall micellar migration velocity is slowed compared to the bulk flow of solvent.

Since analytes can partition into and out of the micelle, the requirements for a separation process are at hand. When an analyte is associated with a micelle, its overall migration velocity is slowed. When an uncharged analyte resides in the bulk phase, its migration velocity is that of the EOF. Therefore, analytes that have greater affinity for the micelle have slower migration velocities compared to analytes that spend most of their time in the bulk phase.

On examination of the fundamental equations governing MECC (Eqs. 15-16), note that both k' (capacity ratio) and R_s (resolution) at infinite micelle concentration simplify to the general LC equations. MECC is a chromatographic or pseudo-chromatographic process.

$$k' = \frac{t_R - t_o}{t_o (1 - t_R/t_{mc})} \quad (15)$$

$$R_s = \frac{\sqrt{N}}{4} \left(\frac{\alpha - 1}{\alpha} \right) \left(\frac{k'_2}{1 + k'_2} \right) \left(\frac{1 - t_o/t_{mc}}{1 + (t_o/t_{mc} k'_1)} \right) \quad (16)$$

Both cationic and anionic surfactants can be employed in MECC. When using a cationic surfactant, the EOF is reversed; therefore, the electrode polarity must also be reversed to detect the analyte.

Migration order. With SDS micelles, the general migration order will be anions, neutrals, and cations. Anions spend more of their time in the bulk phase due to electrostatic repulsions from the micelle. The greater the anionic charge, the more rapid the elution. Neutral molecules are separated exclusively based on hydrophobicity. Cations elute last due to strong electrostatic attraction (*e.g.*, ion-pairing with the micelle). While this is a useful generalization, strong hydrophobic interaction can overcome electrostatic repulsions and attractions. Likewise, the electrophoretic migration of the analytes can also affect the elution order.

The separation of neutral species by CE is a compelling example of the general applicability of the technique. Figure 16 shows the separation of some corticosteroids by MECC. Rather than use SDS, the surfactant most frequently employed, this separation uses sodium cholate, a naturally occurring bile salt, as the micelle-forming surfactant. Since only hydrophobic mechanisms can influence the order of migration, the less polar steroid esters are expected to show longer migration times. This is proven in Figure 16 with hydrocortisone (peak 2) and hydrocortisone acetate (peak 4).

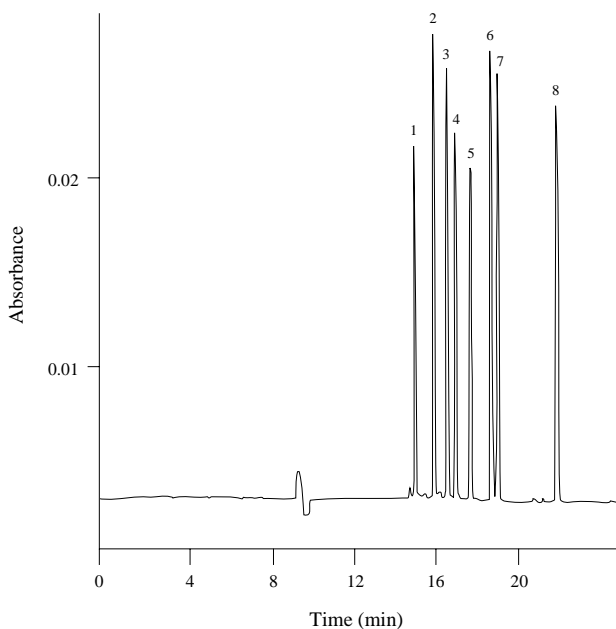

Figure 16. Separation of Corticosteroids by MECC. Buffer, 100 mM sodium cholate, 100 mM borate, pH 8.45. 1, triamcinolone; 2, hydrocortisone; 3, betamethasone; 4, hydrocortisone acetate; 5, dexamethasone acetate; 6, triamcinolone acetonide; 7, fluocinolone acetonide; 8, fluocinolone.

Use of organic modifiers. While organic modifiers have been used in free-resolution separations to overcome solubility problems, their use in MECC is much more profound. Because the organic modifier reduces EOF, the overall peak capacity of the separation is increased due to the greater gap between t_0 and t_{mc} . A more important role of the modifier is the impact on the partition coefficient of a solute between the micelle and the bulk solution. Clearly, the modifier makes the bulk solution more hospitable for hydrophobic analytes. Without the modifier, hydrophobic solutes will elute at or near t_{mc} . The addition of the modifier generally increases migration velocity of hydrophobic species since they now spend more of their time in the bulk phase.

Many organic modifiers are useful in MECC. Methanol and acetonitrile are most commonly employed at concentrations from 5-25%. Methanol and other alcohols tend to slow EOF more so than acetonitrile. For certain separations, aprotic solvents such as tetrahydrofuran (THF), dimethyl sulfoxide (DMSO) and dimethylformamide (DMF) might be useful. DMF is a good solvent because its boiling point is high, thereby minimizing outgassing, a common problem if elevated temperatures are employed. The percentage of organic modifier that is effective is limited by the effect of the solvent on the aggregation number and the micellar ionization number.

Chiral Recognition. Chiral recognition is dependent on the formation of diastereomers either through covalent or electrostatic interactions. There are several approaches for performing chiral separations by CE. Additives such as optically active bile salts and cyclodextrins permit chiral resolution by stereoselective interaction with the solute. With cyclodextrins, this interaction occurs within the molecular cavity by formation of an inclusion complex. The L-complexes tend to be more stable and have longer migration times. With bile salts, the interaction probably occurs at the surface of the micelle. The mechanism of separation is similar, if not identical, to conventional MECC. When an analyte is complexed with the micellar or cyclodextrin additive, its migration velocity is slowed relative to the bulk phase. The enantiomer that forms the more stable complex will always show a longer migration time because of this effect. The main disadvantage of this approach towards chiral recognition is that it is difficult to predict which analytes will optically resolve with a particular additive.

Another approach to chiral selectivity is precapillary derivatization. The analyte is derivatized with an optically active reagent to form covalently bound diastereomers. The diastereomers are usually easily separated by MECC. There are several advantages and disadvantages with this approach. The advantages include: enhanced sensitivity since the tag can be a good chromophore or fluorophore, and predictable results, particularly when the analyte's chiral center and reactive site are relatively close to each other. The major disadvantage is that complex assay validation as a check for completeness of derivatization, derivative stability, and freedom from racemization must be performed. The separation of chiral amino acids derivatized with Marfey's reagent (1-fluoro-2,4-dinitrophenyl-5-L-alanine) is shown in Figure 17.

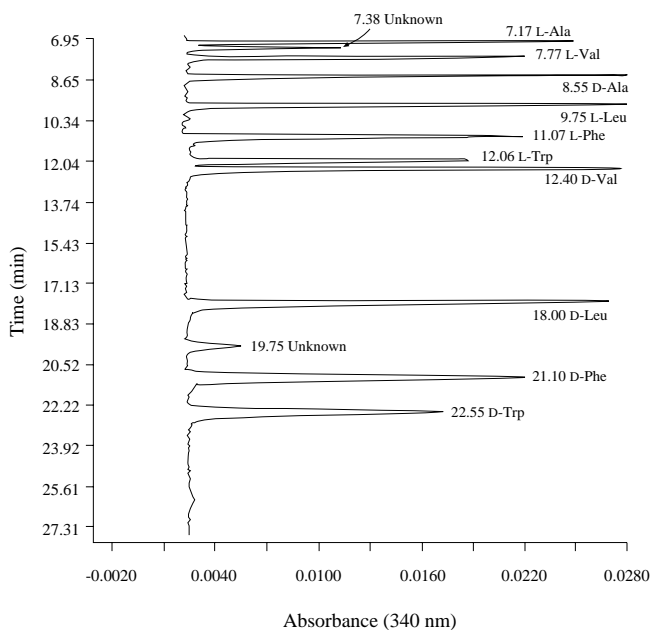

Figure 17. Separation of Chiral Amino Acids Derivatized with Marfey's Reagent. Buffer, 100 mM sodium borate, 200 mM SDS, 5% acetonitrile, pH 8.5.

Applications. A broad base of small-molecule applications has already appeared in the literature. Table 5 contains a summary of some of these applications along with buffer recipes.

Table 5. Applications of MECC

Analyte	Buffer	Reference
Modified nucleic acids	75 mM SDS, 10 mM borate, 10 mM PO ₄ , pH 8.4	<i>J. Chromatogr.</i> 48, 193 (1987)
Angiotensins	10 mM Tris-PO ₄ , 50 mM DTAB, pH 7.05	<i>J. Chromatogr.</i> 519, 189 (1990)
Penicillins	20 mM PO ₄ , 100 mM SDS, pH 8.5	<i>J. Chromatogr.</i> 515, 245 (1990)
OPA-amino acids	50 mM borate, 15% MeOH, 2% THF, 50 mM SDS, pH 9.5	<i>J. Chromatogr.</i> 486, 55 (1988)
Urinary porphyrins	85 mM SDS, 17 mM CAPS, 15% MeOH, pH 11	<i>J. Chromatogr.</i> 516, 271 (1990)
Aspirin/caffeine	50 mM SDS, 20 PO ₄ , pH 11	<i>Anal. Chem.</i> 59, 2773 (1987)
Cold prep (14 drugs)	50 mM sodium deoxycholate or 100 mM sodium taurocholate, 20 mM PO ₄ , pH 9	<i>J. Chromatogr.</i> 498, 313 (1990)
Water-soluble vitamins	50 mM SDS, 20 mM PO ₄ -borate, pH 9	<i>J. Chromatogr.</i> 465, 331 (1989)
Water-soluble vitamins	50 mM SDS, 20 mM PO ₄ , pH 9	<i>J. Chromatogr.</i> 447, 133 (1988)
β -Lactam antibiotics	150 mM SDS, 20 mM PO ₄ -borate, pH 9	<i>J. Chromatogr.</i> 477, 259 (1989)
Phenols	50 mM SDS, 25 mM borate, 50 mM PO ₄ , pH 7	<i>Anal. Chem.</i> 56, 111 (1984)
DNS-methylamine/DNS-methyl- <i>d</i> ₅ -amine	25 mM SDS, 25% MeOH, 25 mM PO ₄ , 62.5 mM borate, 4.28 mM NaHCO ₃ , pH 8	<i>Anal. Chem.</i> 61, 491 (1989)
Chiral drugs	50 mM taurodeoxycholate, 20 mM borate-PO ₄ , pH 7	<i>J. Microcol. Sep.</i> 1, 234 (1989)
Catecholamines	10 mM SDS, 10 mM PO ₄ , 6 mM borate, pH 7	<i>J. Chromatogr.</i> 411, 299 (1988)
Chlorinated phenols	70 mM SDS, 50 mM PO ₄ , 25 mM borate	<i>J. Chromatogr.</i> 348, 39 (1985)
Small oligonucleotides	50 mM SDS, 5 mM Tris-borate, 3 mM Zn(II) 2 M urea, pH 7	<i>Chromatographia</i> 30, 15 (1990)
Sulfonamides	50 mM SDS, 20 mM PO ₄ , pH 7	<i>Chromatographia</i> 30, 7 (1990)

Selecting the mode of capillary electrophoresis

Table 6 can be used to help select the most advantageous mode of electrophoresis as a starting point in methods development. The uppermost listing in each category of the chart is likely to yield acceptable results in the shortest time frame.

Table 6. Selecting the Mode of Capillary Electrophoresis

Small Ions	Small Molecules	Peptides	Proteins	Oligonucleotides	DNA
CZE	MECC	CZE	CZE	CGE	CGE
ITP	CZE	MECC	CGE	MECC	
	ITP	IEF	IEF		
		CGE	ITP		
		ITP			

Approaches to methods development by CZE and MECC

Before you attempt a new separation, some information gathering will be very useful. Is the compound soluble in water at concentrations up to 1 mg/mL? Is it soluble at all pH's? If aqueous solubility is a problem, will small amounts (up to 25%) of methanol or acetonitrile solubilize it? Will small molecules solubilize using 100 mM SDS? For proteins, will 7 M urea or a dispersant such as ethylene glycol help? Is the analyte unstable at certain pH's? Is the compound thermally labile? What is the wavelength of maximum UV absorption? How many components are expected in the mixture? What is the concentration expected of each component?

Developing a method by CZE

A great number of options and tools for methods development are available for CZE. In this exercise, the processes for separating a new protein will be reviewed. For starting conditions, use a 75-cm capillary run at 25°C at 20 kV with the detector set at 214 nm. Make a 1-s injection of a 1 mg/mL solution. Use a 100 mM buffer at the appropriate pH.

- 1) Acid stable—use a buffer pH below the pI;
Acid labile—select a pH at least 1 unit above the pI.
- 2) Solubility problem—add a modifier such as urea or ethylene glycol.
- 3) Adsorption problem—use an additive such as a sulfonic acid, a salt, or switch to a treated capillary.
- 4) Good efficiency, poor separation—adjust the pH.
- 5) Poor efficiency—increase ionic strength of buffer, add a salt in which the protein is stable.

In most cases, you will be able to get a good separation in a relatively short time frame. Some samples may be quite difficult and you may have to spend considerable time carefully selecting buffers and buffer additives.

Developing a method by MECC

MECC is a good separation mechanism for small molecules. The upper molecular weight has not yet been established. Proteins are not well separated by this technique.

Good starting conditions are 100 mM SDS in pH 7, 50 mM phosphate-borate buffer, after which adjustments in SDS concentration, pH, and organic modifier may be necessary. Some guidelines are:

- 1) Long separation times, good resolution—increase pH, decrease SDS.
- 2) Long separation times, poor resolution—use organic modifier.
- 3) Short separation times, poor resolution—increase SDS.
- 4) Short separation times, moderate resolution—decrease pH, increase SDS.

The use of the organic modifier is especially powerful in MECC. Acetonitrile is the solvent of first choice since it has little impact on the EOF. Alcohols may also be useful, but the separation times can become lengthy. Under the proper conditions, the resolving power and peak capacity far exceed HPLC. It takes no more than a few days to develop most separations.

Automated methods development

The P/ACE™ Systems 2050 and 2100 have the capability of performing multiple separations with a variety of buffer solutions. This feature offers the possibility of automated, unattended methods development since fresh buffers in both the anode and cathode reservoirs can be used for each run. In this fashion, parameters such as pH, buffer concentration, additive type, and surfactant concentration, among other factors, can be optimized in a logical and systematic manner.

There are a few guidelines that will prove useful to ensure the efficient generation of applications information:

- 1) Perform a few preliminary separations to gain a general understanding of the problem.
- 2) Set the run time for the maximum expected separation time. For example, with MECC, this would correspond to the highest surfactant concentration employed.

- 3) Some buffers such as phosphate permanently alter the wall chemistry; use these buffers last.
- 4) When switching from CZE to MECC, allow sufficient time (at least 0.5 h) for the capillary to equilibrate with the surfactant solution.
- 5) Program a 0.1 M sodium hydroxide wash between each run.
- 6) When determining the optimum temperature, allow sufficient time for thermal equilibration.
- 7) Modify only one experimental variable at a time.

Suggested reading

At the present time, no textbooks are available on capillary electrophoresis. The following bibliography summarizes a number of articles that are useful for developing a basic understanding of modern CE. For starters, read *Journal of Chromatography* volumes 480 and 516. These are the conference proceedings of HPCE '89 and '90, respectively. A tremendous amount of information is available in these volumes and the soon-to-be-published proceedings from HPCE '91. Other useful papers are listed below in reverse chronological order.

Benefits of automation in the separation of biomolecules by high performance capillary electrophoresis, McLaughlin, G.; Palmieri, R.; Anderson, K., *Techniques in Protein Chemistry II*, Academic Press, 3-19 (1991)

Indirect detection methods for capillary separations, Yeung, E. S.; Kuhr, W. G., *Anal. Chem.* 63, 275A-282A (1991)

Fluorescence detection in capillary electrophoresis: evaluation of derivatizing reagents and techniques, Albin, M.; Weinberger, R.; Sapp, E.; Moring, S., *Anal. Chem.* 63, 417-422 (1991)

Production of polyacrylamide gel filled capillaries for capillary gel electrophoresis (CGE): Influence of capillary surface pretreatment on performance and stability, Yin, H. F.; Juergen, A.; Schomburg, G., *J. High Resolut. Chromatogr.* 13, 624-627 (1990)

Influence of buffer concentration, capillary internal diameter and forced convection on resolution in capillary zone electrophoresis, Rasmussen, H. T.; McNair, H. M., *J. Chromatogr.* 516, 223-231 (1990)

Isotachopheresis in open-tubular fused-silica capillaries: impact of electroosmosis on zone formation and displacement, Thormann, W., *J. Chromatogr.* 516, 211-217 (1990)

High speed DNA sequencing by capillary electrophoresis, Luckey, J. A.; Drossman, H.; Kostichka, A.J.; Mead, D. A.; D'Cunha, J.; Norris, T. B.; Smith, L. M., *Nucleic Acids Res.* 18, 4417-4421 (1990)

Method optimization in capillary zone electrophoretic analysis of hGH tryptic digest fragments, Nielsen, R. G.; Rickard, E. C., *J. Chromatogr.* 516, 99-114 (1990)

Construction, evaluation and analytical operation of a modular capillary electrophoresis instrument, Lux, J. A.; Yin, H. F.; Schomburg, G., *Chromatographia* 30, 7-15 (1990)

Atmospheric pressure ionization mass spectrometry. Detection for the separation sciences, Huang, E. C.; Wachs, T.; Conboy, J. J.; Henion, J. D., *Anal. Chem.* 62, 713A-722A, 724A-725A (1990)

A simple method for the production of gel-filled capillaries for capillary gel electrophoresis, Lux, J. A.; Yin, H. F.; Schomburg, G., *J. High Resolut. Chromatogr.* 13, 436-437 (1990)

Quantitation of ribonucleotides from base-hydrolyzed RNA using capillary zone electrophoresis, Huang, X.; Shear, J. B.; Zare, R.N., *Anal. Chem.* 62, 2049-2051 (1990)

Analysis of oligonucleotides by capillary gel electrophoresis, Paulus, A.; Ohms, J. I., *J. Chromatogr.* 507, 113-123 (1990)

Effect of surfactant structures on the separation of cold medicine ingredients by micellar electrokinetic chromatography, Nishi, H.; Fukuyama, T.; Matsuo, M.; Terabe, S., *J. Pharm. Sci.* 79, 519-523 (1990)

Separation and determination of the ingredients of a cold medicine by micellar electrokinetic chromatography with bile salts, Nishi, H.; Fukuyama, T.; Matsuo, M.; Terabe, S., *J. Chromatogr.* 498, 313-323 (1990)

Enantioselective hydrophobic entanglement of enantiomeric solutes with chiral functionalized micelles by electrokinetic chromatography, Dobashi, A.; Ono, T.; Hara, S.; Yamaguchi, J., *J. Chromatogr.* 480, 413-20 (1989)

High-speed micellar electrokinetic capillary chromatography of the common phosphorylated nucleosides, Liu, J.; Banks, J. F., Jr.; Novotny, M., *J. Microcolumn Sep.* 11, 36-41 (1989)

Chiral separation by electrokinetic chromatography with bile salt micelles, Terabe, S.; Shibata, M.; Miyashita, Y., *J. Chromatogr.* 480, 403-411 (1989)

Separation of β -lactam antibiotics by micellar electrokinetic chromatography, Nishi, H.; Tsumagari, N.; Kakimoto, T.; Terabe, S., *J. Chromatogr.* 477, 259-270 (1989)

Capillary zone electrophoretic separation of peptides and proteins using low pH buffers in modified silica capillaries, McCormick, R. M., *Anal. Chem.* 60, 2322-2328 (1988)

Improved electrospray ionization interface for capillary zone electrophoresis-mass spectrometry, Smith, R. D.; Barinaga, C. J.; Udseth, H. R., *Anal. Chem.* 60, 1948-1952 (1988)

Capillary electrophoresis, Compton, S.W.; Brownlee, R. G., *BioTechniques* 6, 432-440 (1988)

High-performance capillary electrophoresis using open tubes and gels, Cohen, A. S.; Paulus, A.; Karger, B. L., *Chromatographia* 24, 15-24 (1987)

The effect of electrolyte chain length on electroosmotic flow in high voltage capillary zone electrophoresis, Altria, K. D.; Simpson, C. F., *Anal. Proc. (London)* 25, 85 (1988)

Miniaturization in pressure and electroosmotically driven liquid chromatography: some theoretical considerations, Knox, J. H.; Grant, I. H., *Chromatographia* 24, 135-143 (1987)

High voltage capillary zone electrophoresis: operating parameters effects on electroosmotic flows and electrophoretic mobilities, Altria, K. D.; Simpson, C. F., *Chromatographia* 24, 527-532 (1987)

Modification of electroosmotic flow with cetyltrimethylammonium bromide in capillary zone electrophoresis, Tsuda, T., *HRC & CC, J. High Resolut. Chromatogr. Chromatogr. Commun.* 10, 622-624 (1987)

Bias in quantitative capillary zone electrophoresis caused by electrokinetic sample injection, Huang, X.; Gordon, M. J.; Zare, R. N., *Anal. Chem.* 60, 375-377 (1988)

High-performance sodium dodecyl sulfate polyacrylamide gel capillary electrophoresis of peptides and proteins, Cohen, A. S.; Karger, B. L., *J. Chromatogr.* 397, 409-417 (1987)

Measurement of electroosmotic flows in high-voltage capillary zone electrophoresis, Altria, K. D.; Simpson, C. F., *Anal. Proc. (London)* 23, 453-454 (1986)

Control of electroosmosis in coated quartz capillaries, Herren, B. J.; Shafer, S. G.; Van Alstine, J.; Harris, J. M. Snyder, R. S., *J. Colloid Interface Sci.* 115, 46-55 (1987)

Electrokinetic resolution of amino acid enantiomers with copper(II)-aspartame support electrolyte, Gozel, P.; Gassmann, E.; Michelsen, H.; Zare, R. N., *Anal. Chem.* 59, 44-49 (1987)

Capillary zone electrophoresis of proteins in untreated fused silica tubing, Lauer, H. H.; McManigill, D., *Anal. Chem.* 58, 166-170 (1986)

Electrokinetic separations with micellar solutions and open-tubular capillaries, Terabe, S.; Otsuka, K.; Ichikawa, K.; Tsuchiya, A.; Ando, T., *Anal. Chem.* 56, 111-113 (1984)

High-resolution separations based on electrophoresis and electroosmosis, Jorgenson, J. W.; Lukacs, K. D., *J. Chromatogr.* 218, 209-216 (1981)

Free-zone electrophoresis in glass capillaries, Jorgenson, J. W.; Lukacs, K. D., *Clin. Chem.* 27, 1551-1553 (1981)

Zone electrophoresis in open-tubular glass capillaries, Jorgenson, J. W.; Lukacs, K. D., *Anal. Chem.* 53, 1298-1302 (1981)